

INSTRUCTION MANUAL

FOTEMP C15

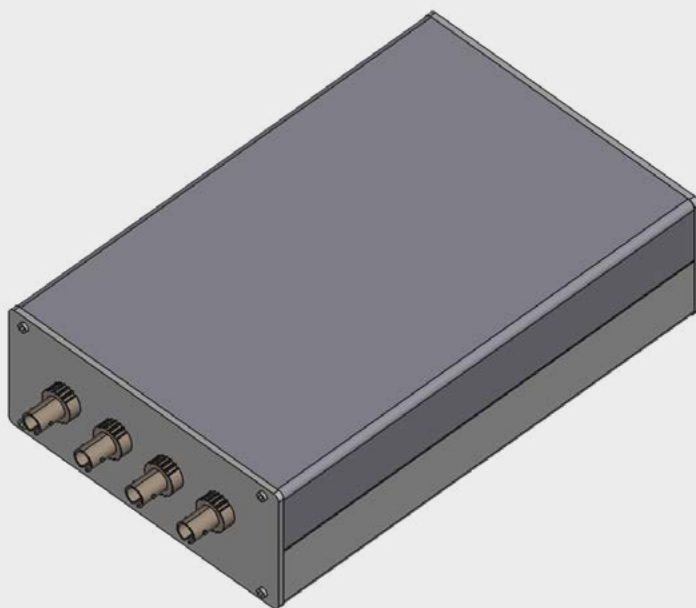

Content index

General	3
Safety	3
Unpacking, inspection, service	3
Product description	3
Calibration	4
Quick start	4
Installation.....	5
Sensor connection.....	6
Sensor handling.....	6
Sensor/connector cleaning	7
Serial communication.....	7
Troubleshooting	8

General

The fiber optic thermometer described in this instruction manual has been designed and manufactured using state-of-the-art technology.

All components undergo strict quality and environmental criteria during production. This manual contains important information on how to handle the device.

Follow all safety and work instructions to ensure safe use. Please adhere also to the relevant local accident prevention and general safety regulations for the device's range of use.

The operating instructions are an essential part of the product and should be kept near the device and readily accessible to trained personnel at all times. Qualified personnel must carefully read and understand the operating instructions before using the device.

The manufacturer's liability is void if the device is mis-used, operating instructions are not followed, unqualified personnel are assigned, or unauthorized modifications are made.

General terms and conditions contained apply. Subject to technical changes.

Safety

Safety instructions

This manual contains important information to ensure personal safety and to prevent damage. Safety instructions in this manual are shown in three different forms to emphasize important information.

	WARNING
Indicates a potentially dangerous situation that can result in equipment damage, injury or death if not avoided.	

	CAUTION
Indicates a potentially dangerous situation that can result in minor injuries or damage to equipment or the environment if not avoided.	

	NOTE
Points out useful tips, recommendations, and information for efficient and trouble-free operation.	

Skilled personnel:

Only qualified personnel should commission and operate the devices.

Skilled personnel are those with technical training, knowledge of measurement and control technology, and experience and knowledge of country-specific regulations, current standards, and directives.

Intended use:

The device has been designed and built solely for the described intended use and must only be used accordingly. The technical specifications contained in this manual must be observed.

Unpacking, inspection, service

Please make sure to follow these instructions when unpacking and inspecting your system components:

1. Check all materials against the enclosed packing list.
2. Carefully unpack and inspect all components for visible damage.
3. Save all packing materials, until you have inspected all components and find that there is no obvious or hidden damage.
4. If you notice any damage upon unpacking, contact us immediately.
5. In case of a malfunction or service request, please contact us.

Technical support

Email: customerservice@it.comem.com
 TD +49 351 843 599 0

Equipment return address

COMEM Optocon GmbH
 Washingtonstrasse 16/16a
 01139 Dresden, Germany

Disposal

Inoperable devices must be disposed of in compliance with local regulations for electronic materials.

Product description

The FOTEMP C15 comes with compact housing and offers various mounting options, making it suitable for a wide range of external conditions. The system uses fiber optic sensors and is ideal for measuring temperatures in environments with microwave, high frequency, high voltage, and magnetic fields, as well as aggressive conditions where the use of metallic sensors (RTC, TC, capillary, etc.) is not feasible.

It is suitable for various applications, including:

- EMI, RFI and microwave environments
- High voltage environments
- Harsh and hazardous environments
- Aerospace applications
- Process monitoring
- Medical applications
- Oil-filled transformers
- MRI and other magnetic field applications.

The probes used for temperature measurement consist of a PTFE-housed glass fiber with a GaAs crystal (gallium arsenide) at the tip, the probe is completely non-metallic and therefore completely non-conductive.

COMEM's fiber optic sensors offer complete immunity to RF and microwave radiation with high temperature operating capability, intrinsic safety, and non-invasive use. The probes are also designed to withstand harsh and corrosive environments.

Starting at a light wavelength of 850nm GaAs becomes optical translucent. Since the position of the band gap is temperature dependent, it shifts about 0.4nm/Kelvin. The measurement device contains a light source and a device for the spectral detection of the band gap. This guarantees fast, repeatable, and reproducible measurements.

Thanks to its accompanying software FOTEMP Assistant 2, measurement results can be easily controlled and monitored. Over the entire life of the system re-calibration is not required to remain within the specifications. Inoperable instruments must be disposed of in compliance with local regulations for electronic materials.

Measurement	
Measurement Range	-200 °C to 300 °C
Measuring Time	< 250 ms per Channel
Accuracy (Standard Deviation)	0.2 K
Resolution	0.1 K
Probes	Compatible with all COMEM fiber optic temperature probes

Environment	
Communication Protocols	ASCII, Modbus
Interfaces	RS232, RS485, USB
Operating Temperature	-20 °C to 60 °C
Storage Temperature	-20 °C to 70 °C
Connector Type	ST

Device	
Channel	1, 2, 4
Display	Not available
Additional Interfaces	Not available
Data Logging	Not available
Power Supply	12 VDC
Dimension	105 x 44.5 x 164 mm
Weight	0,5 kg

Calibration

For accurate temperature measurements in critical areas, we provide a comprehensive calibration service for our fiber optic temperature measurement devices. Our modern labs and our qualified staff ensure very accurate and fast calibration.

You will receive your unit back within a few days, ready to start your fiber optic measurement projects. Your fiber optic thermometer comes factory-calibrated. An annual re-calibration is not necessary, unless required by internal company regulations. All calibrations are performed at our factory.

We provide a full certificate of test results for each calibrated device.

For more information contact us:
customerservice@it.comem.com

Quick start

This quick reference guide provides an overview for quick usage. However, it can not replace comprehensive literature containing important information and safety warnings.

Front view

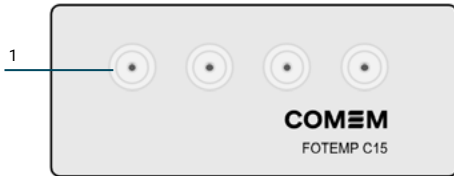

1. Sensor connectors

The sensor connectors are ST-type connectors that match with each of the optical temperature sensors. If you need to extend the fiber optic temperature sensor, please use the COMEM extension cables. For thermometers with less than four channels, only 1 or 2 sensor connectors are used.

Back view

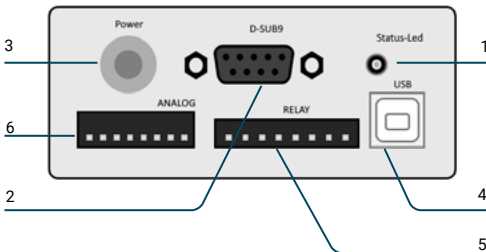

1. Status LED

The LED indicates the status of the channel. If the sensor is damaged, defective, or nonexistent, the LED will flash red. During normal operation when the sensor is available and measurements are being carried out, the LED will flash green.

2. D-SUB9 Connector

Port for RS485 bus.

3. Power supply

Make sure to use only the power supply provided by COMEM.

4. USB interface

USB-B port for communication.

5. Relay header

8 pins for 4 channel-bound relays.

6. Analogue output

8 pins for 4 channel-bound analogue outputs.

Installation

1. Plug the fiber optic temperature sensors into the ST socket.
2. Connect the power supply.
3. After connecting the power supply, the device will start, and the LED will light up green.
4. The device is now ready for measurement.



NOTE

If no sensor is connected or the signal quality is too low, the LED will light up red.



CAUTION

FOTEMP C15 is only compatible with COMEM optocon fiber optic sensors. Do not use temperature sensors from other brands.

General installation guidelines:

When installing the fiber optic device, carefully follow the installation instructions, paying close attention to the order of the instructions.

Sensor connection (Page 6)

The temperature sensors are connected to the ST socket using ST plugs. When inserting the plugs, apply slight pressure against the spring and turn them clockwise. All COMEM fiber optic temperature sensors can be connected.

Sensor handling (Page 6)

The sensor comprises an ST plug at one end and a gallium arsenide crystal at the tip. The crystal is sensitive and should not be subjected to excessive mechanical stress. Please refer to the information regarding the bending radius of the sensor. Forcefully bending the sensor can lead to fiber breakage, resulting in damage that will require repair or replacement.

Serial communication (Page 9)

The device can be connected to a PC via RS485, or USB.

Sensor connection

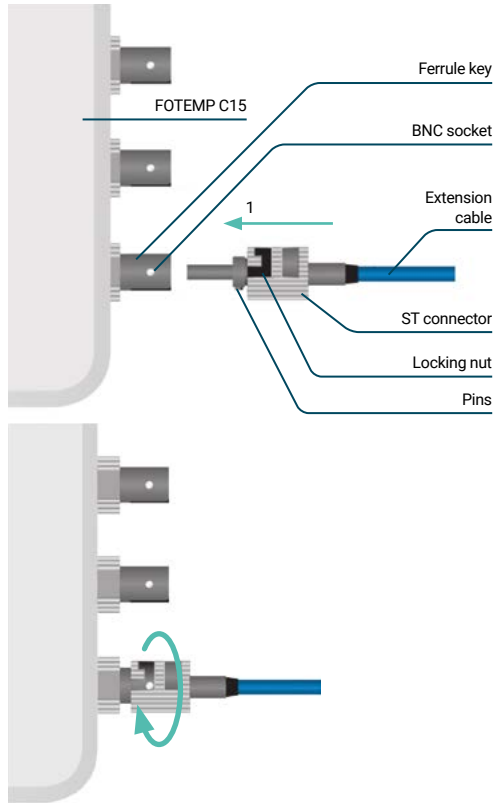

For accurate measurements and to ensure the long life of fiber optic sensors and instruments, it is necessary to clean them regularly. More information about cleaning can be found on page 7.



NOTE

Any unused channels must be protected with supplied dust caps.

Test of sensor functionality

To test the functionality of the sensor, you can place the sensor into a test liquid with a known temperature (e.g. boiling water). The sensor will respond to the temperature within a few seconds.

Sensor handling

Bending radius:

Fibers with a core diameter of 200 μm have a short time (≤ 10 min) bending radius of 10,0 mm and a long time (> 10 min) bending radius of 27,0 mm.

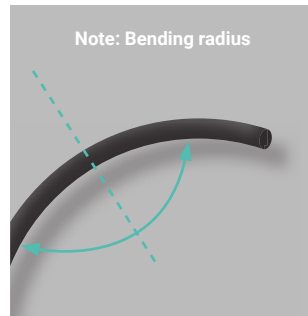
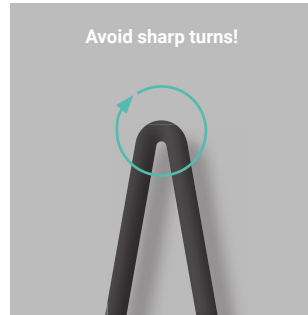

Sensor/connector cleaning

Mechanical load:

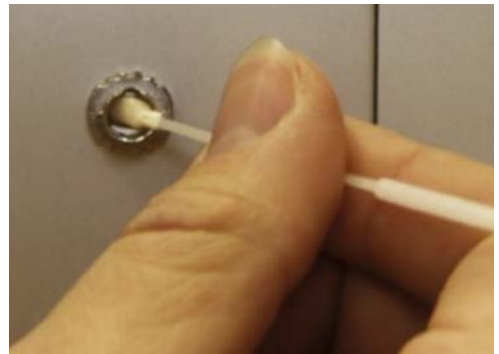
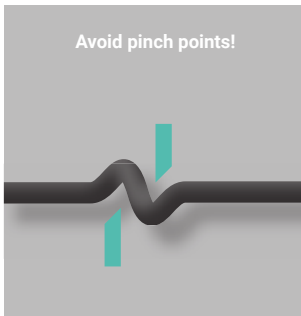
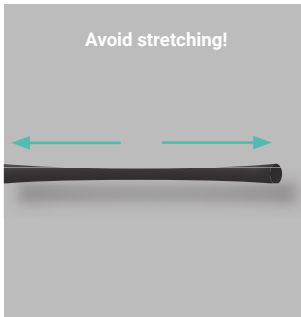

Storage:

When not in use, the sensor should be carefully stored in its delivery box or suitable storage container to prevent bending or crushing.

Instructions

Clean the ST sensor's connector with the connector cleaner. Softly press the connector on the cloth tape and rotate across the tape while rotating the connector. You can clean up to 6 connectors before advancing the tape. Tear off excess tape as required. Take a swab and wet it with the isopropanol wipes. Insert the swab into the internal connector of the conditioner by rotating it smoothly. Avoid using cotton swabs.

Serial communication

You can connect the device to your computer using a USB-C cable. Once connected, you can use our free software FOTEMP Assistant 2, to view temperatures on your computer, customize settings, log temperatures, and display them in charts.

Alternatively, you can communicate with the device using our open ASCII protocol or Modbus.

COMEM SpA

Localita' Signolo 22, S.R. 11
36054 Montebello Vicentino
Vicenza - Italy
Tel +39 0444 449 311

COMEM Optocon GmbH

Washingtonstraße 16/16a
D-01139 Dresden
Germany
Tel +49 (0)351 8435990

Troubleshooting

For more information please contact us or consult the Application note AN206: FOTEMP Device Troubleshooting <https://comem.com/en/library/>.

This installation manual contains essential information for the user required to install & operate the product. In case you need any further information, contact us at customerservice@it.comem.com

www.comem.com

The data and illustrations are not binding. We reserve the right to modify the contents of this document without prior notice following the technical and product developments.

Copyright 2024 COMEM. All rights reserved

Manual-10-2024